

ANCHOR TYPES

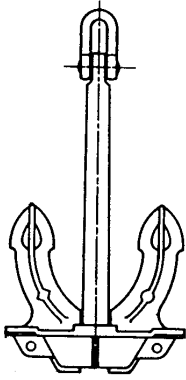

Franklin Offshore Australia Pty Ltd have shown on the following pages the more common types of anchors used however should you require a different model or any further information please do not hesitate to contact us as we are able to source anchors globally to meet your requirements.



Hall

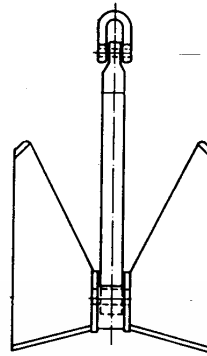
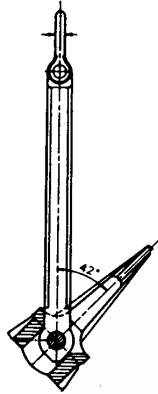

Pool TW

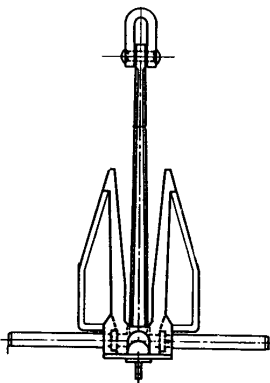
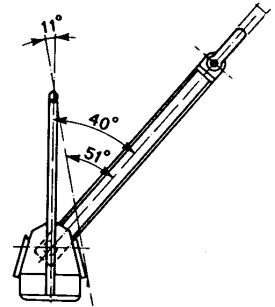

Danforth

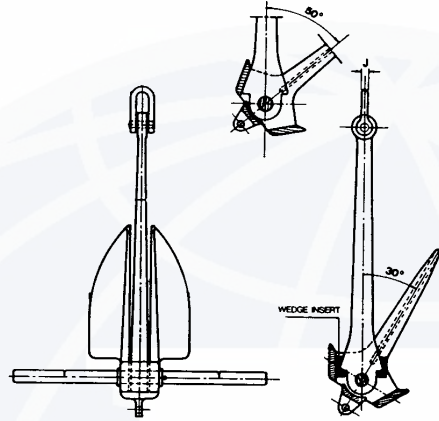
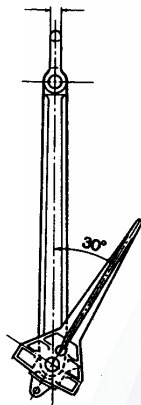

LWT

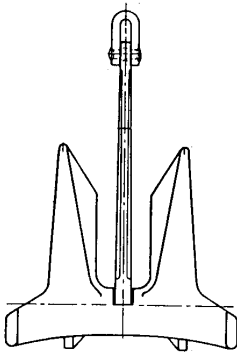

AC14

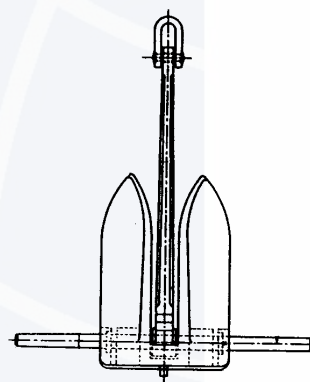
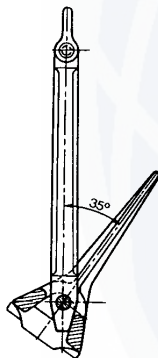

Moorfast

